



INSTALLATION INSTRUCTIONS

PART#: SMX-11HDUCA

FITS: Chevrolet/GMC

•2011-2017 and Up 2500HD/3500HD

Thank you for choosing SuspensionMaxx for your vehicle. This kit is designed to add suspension travel and increase front and ground clearance. Specially designed tools and experience are required to complete the installation properly. These parts should only be installed by a qualified mechanic otherwise an unsafe vehicle and/or injury may result. Consult manufacturers service manual for proper torque specifications and procedures. Instructions are supplied for the leveling kit installation only. Safety is important. Use safe working habits.

WARNING!

This suspension system will enhance off road performance and increase ground clearance. Larger tires will increase vehicle roll center height. The vehicle will handle and respond to driver steering and braking differently from a stock factory equipped passenger car or truck. Extreme care must be used to prevent loss of control or vehicle rollover during abrupt maneuvers both on and off-road. Failure to operate this vehicle safely can result in vehicle damage, serious injury or death to the driver and passengers. Always wear your seat belt and reduce your speed, avoid sharp turns, inclines and abrupt maneuvers. Tread lightly, respect nature and enjoy the Off-Road Experience! Help keep it available for future generations.

Thank You!
SuspensionMAXX Inc.



INSTRUCTIONS

SuspensionMAXX kits are designed to be easily installed and completely reversible to the factory supplied settings. These instructions are supplied for ease of installation, correct procedures and safety. Automotive experience recommended.

VIDEO INSTRUCTIONS

https://youtu.be/YNHU_6CK5gs

NOTE: This kit is design to work with MAXXCam 3, 5, and 7 Kits only



Again, Thank you for your purchase! Enjoy your SuspensionMAXX leveling system!

Questions? E-mail us at tech@suspensionmaxx.com or call 1.888.629.9226

PRELIMINARY STEPS

1. Park vehicle on level surface.
2. Block rear wheels.
3. Using load-rated floor jack and stands, raise and safely support vehicle under certified frame lift points and remove front wheels.

STEP 1 - REMOVE SHOCK ABSORBERS

1. Remove shock absorber by unbolting upper and lower shock mounts.

STEP 2 - DIFFERENTIAL LOWERING SPACERS

1. Remove skid plates to better access differential support mounting locations.
2. Lightly jack and support the differential during the following steps
3. Loosen the passenger side mounting bolts. Do not remove. This will aid in installation of spacers.
4. Remove driver side bolts and remove differential cross member cradle. **FIG. 2-1**
5. Differential case will require slight modification to clear frame at the lowered height.



NOTE: For best results install with MAXXCam Leveling Kits and use included hardware.

6. Use Die grinder to remove excess material around mounts. **FIG. 2-2**

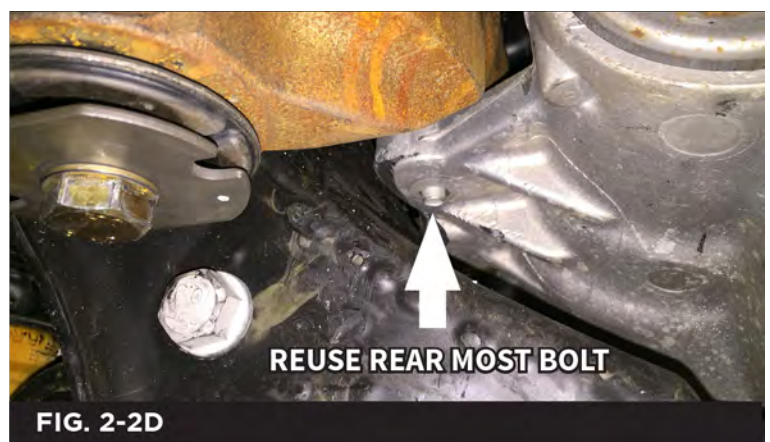
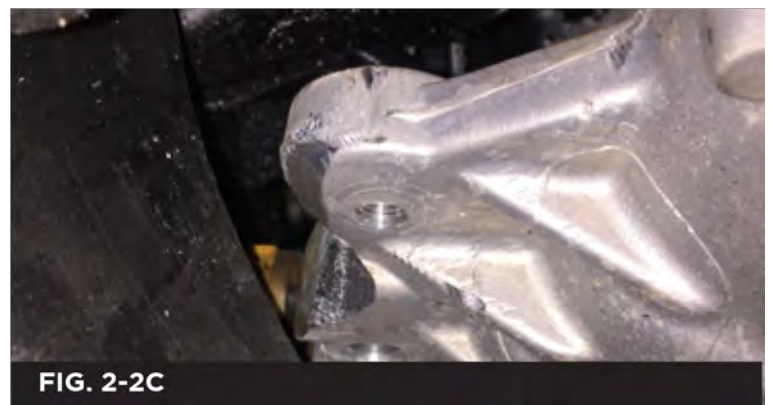
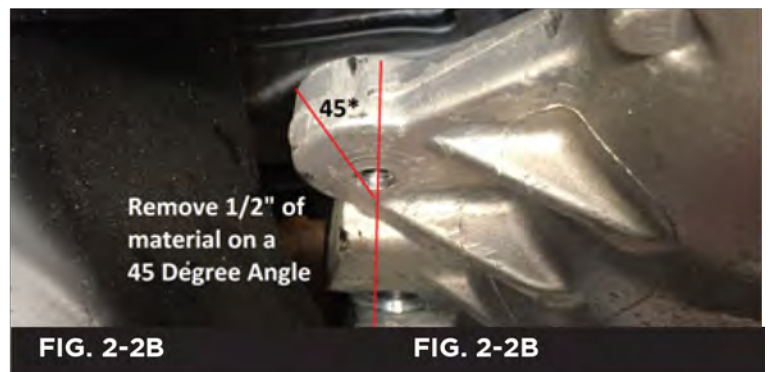

Again, Thank you for your purchase! Enjoy your SuspensionMAXX leveling system!
Questions? E-mail us at tech@suspensionmaxx.com or call 1.888.629.9226

- Align supplied spacers as shown in **FIG. 2-1**
- Reinstall Mounts with supplied bolts. Note: reuse the rear mounting bolt. Be careful to install the longer of the 2 differential mounting bolts in the forward position.

FIG. 2-3

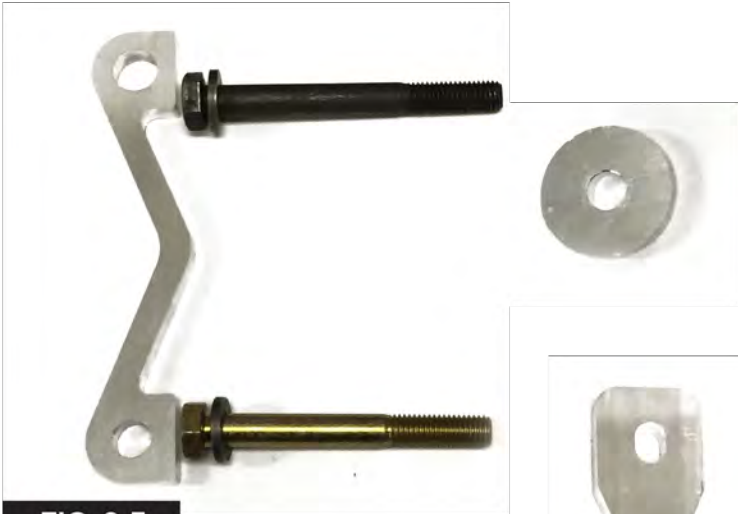

FIG. 2-3

13. Install Passenger side differential spacer. Reuse stock hardware on Passenger side See **FIG. 2-4 & 2-5**
14. Torque mounting nuts to 80Ft LBS.
15. Install four 1" Diameter spacer on skid plate, reuse hardware. **FIG. 2-6**



FIG. 2-4



FIG. 2-5

NOTE: Use 7/16" gold washers to lower skid plate mounting position. **FIG. 2-6**



FIG. 2-6

STEP 3 - INSTALL UPPER CONTROL ARMS

NOTE: Control Arms have a left (Driver Side) and Right (Passenger Side) Designation. See **FIG. 3-1 & 3-2**



FIG. 3-1



FIG. 3-2

- Loosen ball joint nut until finger tight.
- Strike knuckle with ballpeen hammer to separate upper ball joint taper. **Do not use pickle fork. Do not strike control arm.**
- Support knuckle to be sure to the inner axle joint does not become dislodged.
- Remove upper control arm Cam bolts. You will need to reference original cam bolt location. Helpful hint relocate cam washers to original factory placement.
- Torque upper Cam bolts to 150-170 Ft. LBS.
- Insert ball joint tapered stud to knuckle. Torque Castle nut to 50 Ft LBS Continue to tighten to next available slot. **(NEVER back off the slotted nut to achieve alignment with the hole in the stud.)** Install and spread cotter pin.
- Reinstall shock absorber with new studs and spacers.

FIG. 3-3



FIG. 3-3

- Lightly grease control Arms **3-4 pumps or until boot is inflated.** **FIG. 3-4**
- Install tires and wheels.



FIG. 3-4

Again, Thank you for your purchase! Enjoy your SuspensionMAXX leveling system!
Questions? E-mail us at tech@suspensionmaxx.com or call 1.888.629.9226

10. Align Vehicle to specifications listed below.

NOTE: You now have greaseable upper ball joints, located underneath the washer and dust grommet. When reinstalling the dust grommet and washer, after greasing the ball joint. Carefully tighten acorn nut till snug. Do not over tighten.



FIG. 3-5



FIG. 3-6

ALIGNMENT SPECS

CASTER: 2.7* +OR- .25 Degree

CAMBER: 0.4* + OR - 0.2 Degrees Prefer to be equal side to side

TOTAL TOE: 1/8" + OR - 1/16"

PREFERRED RIDE HEIGHT: 27-3/4"

(Wheel Center Line from hub to bottom of fender well) At curb height

PREFERRED TIRE SIZES

- Factory or 9" Positive Wheel
- 295/70R18
- 285/75R18
- 295/65R20
- 275/65R20









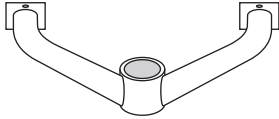

Again, Thank you for your purchase! Enjoy your SuspensionMAXX leveling system!

Questions? E-mail us at tech@suspensionmaxx.com or call 1.888.629.9226

SMX-11HDUCA STAGE 2

#	PART NAME	GRAPHIC FORM	QTY
---	-----------	--------------	-----

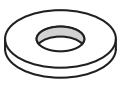
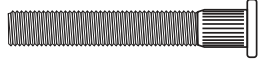

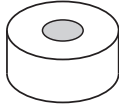
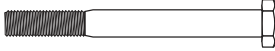
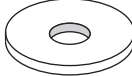
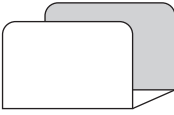

UPPER CONTROL ARM PARTS

A	Upper Control Arm Frame		2PC
B	"Bowtie" Differential Spacer		1PC
C	"M" Differential Spacer		1PC
D	"Round" Differential Spacer		1PC
E	Differential Spacer Extension Bolt		2PC
F	7/16 inch Differential Washer		2PC
G	Extra Heavy Skid Plate Spacer		4 PC
H	Splined Shock Absorber Studs		4PC
I	Shock Extension Spacers		4PC
J	12mm Strut Stud Lock Nuts		4PC

MAXXCAM PARTS

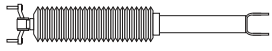
K	MAXXCam Torsion Key		2PC
L	Differential Spacer		4PC
M	14mm Differential Spacer Bolt		4PC
N	2 inch OD Differential Bolt Washer		4PC
O	MAXXCam Alignment Clip		1PC

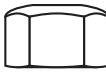
SHOCK ABSORBER PARTS

K	Front Shock Absorbers		2PC
L	Rear Shock Absorbers		4PC
M	Nut		4PC
N	Washer		4PC



INSTALLATION INSTRUCTIONS

PART#: SMX-MC7

FITS: Chevrolet/GMC

•2017 and Up 2500HD/3500HD

Thank you for choosing SuspensionMaxx for your vehicle. This kit is designed to add suspension travel and increase front and ground clearance. Specially designed tools and experience are required to complete the installation properly. These parts should only be installed by a qualified mechanic otherwise an unsafe vehicle and/or injury may result. Consult manufactures service manual for proper torque specifications and procedures. Instructions are supplied for the leveling kit installation only. Safety is important. Use safe working habits.

WARNING!

This suspension system will enhance off road performance and increase ground clearance. Larger tires will increase vehicle roll center height. The vehicle will handle and respond to driver steering and braking differently from a stock factory equipped passenger car or truck. Extreme care must be used to prevent loss of control or vehicle rollover during abrupt maneuvers both on and off-road. Failure to operate this vehicle safely can result in vehicle damage, serious injury or death to the driver and passengers. Always wear your seat belt and reduce your speed, avoid sharp turns, inclines and abrupt maneuvers. Tread lightly, respect nature and enjoy the Off-Road Experience! Help keep it available for future generations.

Thank You!
SuspensionMAXX Inc.



INSTRUCTIONS

SuspensionMAXX kits are designed to be easily installed and completely reversible to the factory supplied settings. These instructions are supplied for ease of installation, correct procedures and safety. Automotive experience recommended.

REQUIRED TOOLS

- Torsion Bar Unloader Tool (SMX-2011MT or CH-48809)
- Load-rated floor jack
- Load-rated jack stands
- 7/8" or 22mm socket for lug-nuts and differential bolts
- 18mm & 19mm wrenches for shock absorber
- 21mm wrench for OEM differential bolt
- 21mm socket for OEM differential bolts
- 1" socket for SMX-2011MT
- 1/2" torque wrench rated up to 150 ft/lbs
- Anti-seize



Again, Thank you for your purchase! Enjoy your SuspensionMAXX leveling system!

Questions? E-mail us at tech@suspensionmaxx.com or call 1.888.629.9226

PRELIMINARY STEPS

1. Park vehicle on level surface.
2. Block rear wheels.
3. Using load-rated floor jack and stands, raise and safely support vehicle under certified frame lift points and remove front wheels.

STEP 1: Removal

1. Using specified torsion bar unloader tool, increase tension on torsion bar adjusting lever, remove height adjustment bolt and horizontal adjusting nut when unloaded.
2. Slowly relieve torsion bar tension and remove unloader tool.
3. Slide torsion bar forward, disengaging hex from lever.

CAUTION: Disengaging lever can fall from vehicle and cause injury.

NOTICE: Torsion bar may be frozen in lever, added force may be required for disassembly.

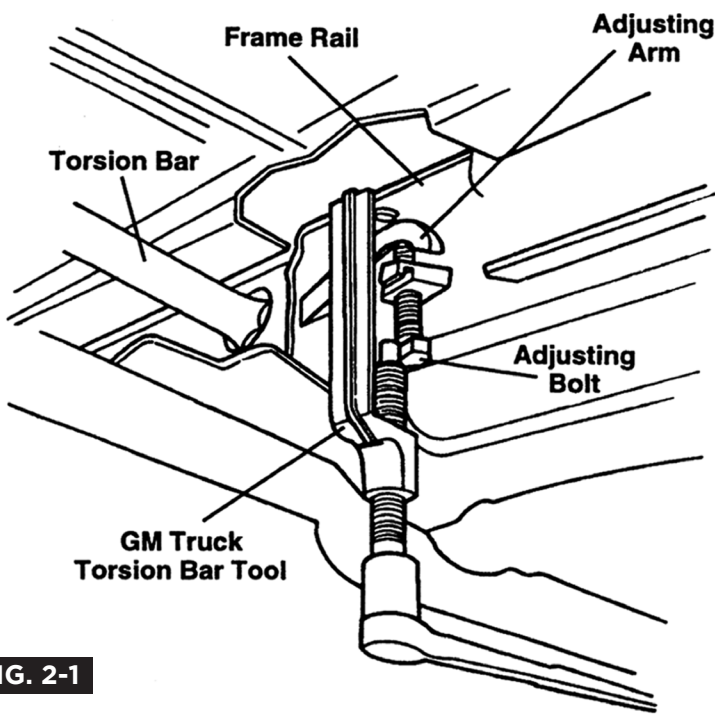

FIG. 2-1

STEP 2: Shock Relocation Kit Installation

1. Support lower control arm with suitable floor jack or stand.
2. Remove upper and lower shock mounting hardware (21mm) Remove shock from vehicle .

3. Remove OE shock studs by supporting the shock by it's cross-pin and striking the stud out from the cross-pin. **(FIG 2-1)**



4. Flip the shock over strike new studs into shock cross-pin. **(FIG 2-2)**



5. Reinstall shock with spacer sleeve. Torque supplied nut to **50ft/lbs.**
6. Reinstall wire loom clips onto exposed shock threads.
7. Repeat steps 1 through 4 for each side of the vehicle.

STEP 3: Differential Spacer Installation

1. Support differential with suitable floor jack or stand.
2. Loosen four differential mounting bolts with 21mm socket. **DO NOT** remove at this time.

3. Remove one differential mounting bolt at a time.
4. Carefully lower the differential and install differential spacers one at a time.



5. Install new differential bolt with heavy duty washer. **DO NOT** tighten.
6. Repeat steps 3-5 on the remaining 3 differential bolts.



7. Tighten all four differential mounting bolts. Torque to **85ft/lbs**

NOTE: Tight clearance between differential and cross-member, centering of the differential may be required to keep proper clearance. Recentering or shifting of the differential may be required to maintain proper clearances.

Again, Thank you for your purchase! Enjoy your SuspensionMAXX leveling system!

Questions? E-mail us at tech@suspensionmaxx.com or call 1.888.629.9226

STEP 4: Calibration

NOTICE: Calibration is required before installation

1. To calibrate match **A** or **B**, stamped on the internal hub, with the appropriate numbered outer position.
2. Apply anti-seize on gear tooth area to ease future disassembly.
3. Install hub alignment clip to aid in holding the **MAXXCam 7's** gear in place. (Only 1 supplied)
4. Reinstall **MAXXCam 7** in vehicle.
5. Remove hub alignment clip. (Discard - not required)
6. Adjust suspension ride height within specified range.

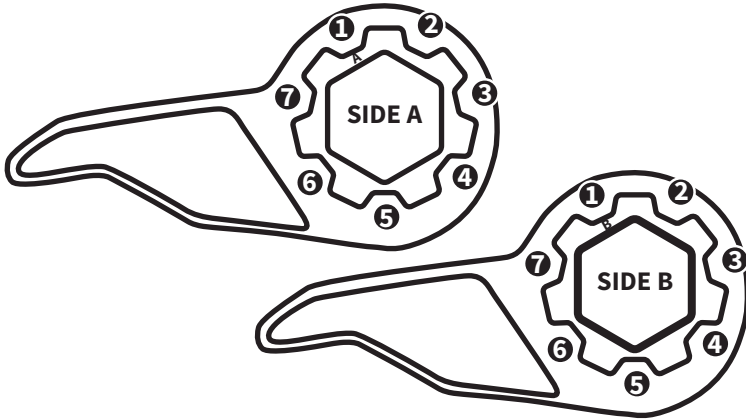

CALIBRATION CHART

Actual measurements may vary due to initial starting position, load and bar fatigue.

2017 & Up Silverado HD & Sierra HD

ONLY RECOMMENDED WITH AFTERMARKET UPPER CONTROL ARMS

B1 = +2.5"

A1 = +1.7-2.5"

INCREASE

B2 = +1.5"

DECREASE

B3 = -1.5"

A3 = -2.5"

Record position for reference:

LEFT _____

RIGHT _____

INSTALLED ___/___/___

MILEAGE _____

NOTE: Lift heights shown on chart reflect the initial height achieved by the MAXXCam prior to adjustment of the torsion bar bolt. *Results may vary.*

This kit adds suspension travel only and will not add load carrying capacity to the suspension system.

DO NOT OVERLOAD

This kit can be over calibrated. Over adjustment of the torsion bar is not recommended!

NOTICE ALL POSITIONS MAY NOT BE USED IN SOME APPLICATIONS

NOTICE: WHEEL ALIGNMENT REQUIRED

WHEEL ALIGNMENT SPECS W/ LEVELING KIT

CAMBER	0.0Deg. +/- 0.5Deg.
CASTER	2.0Deg. +/- 1.0Deg.
(LEFT TO RIGHT MUST BE EQUAL +/- 0.25Deg.)	
TOTAL TOE	1/8in. +/- 1/16in.

STEP 5: Installation

1. Inspect torsion bars, cross-member support for cracks, rust or damage. Check adjusting bolts and nuts for damage, rust or stripped threads. Replace if necessary.
2. Calibrate MAXXCam 7 as needed to compensate for torsion bar sag and fatigue. **See Calibration Chart.**
3. Install MAXXCam 7 into cross-member, slide torsion bar rearward fully engaging torsion bar hex in MAXXCam 7.

NOTICE: A slight adjustment of torsion bar cross-member may be required to clear MAXXCam 7 Leveling kit (FIG 5-1)

4. Reinstall torsion bar unloader tool. Increase tension on torsion bar unloader tool as required to reinsert horizontal adjusting nut.
5. Reinstall torsion bar adjustment bolt, thread the bolt in until it makes contact with the MAXXCam torsion bar key.

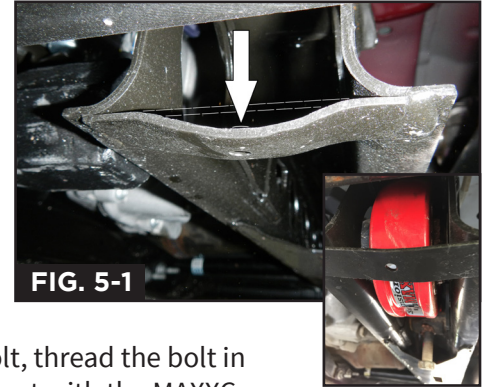

FIG. 5-1

WARNING: INCREASED PRESSURE REQUIRED! USE EXTREME CAUTION!

STEP 6: Adjustments

1. With vehicle sitting on level ground on all four tires check and adjust ride height and be aware of upper control arm gap. As you adjust the torsion bar bolt the upper control arm gap will decrease. The gap must maintain **1/4" - 3/8"** clearance between upper control arm and stop bracket. Adjust until ride height is adequate. Use the torsion bar adjustment bolts to balance ride height between both sides of the vehicle.

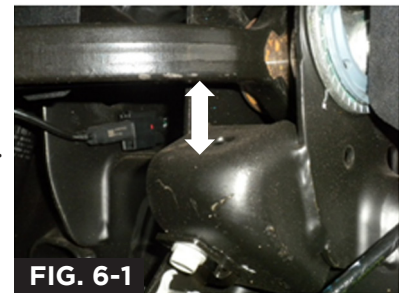

FIG. 6-1

NOTICE: Over-adjustment will result in poor ride and difficulty setting the vehicles wheel alignment.

2. Check and adjust wheel alignment.

NOTICE: For best ride quality set ride height at 2.0" of lift, 26.5" center hub to fender opening. Stock 24.5" on most trucks. See (FIG 6-2)



FIG. 6-2

Again, Thank you for your purchase! Enjoy your SuspensionMAXX leveling system!

Questions? E-mail us at tech@suspensionmaxx.com or call 1.888.629.9226